

A

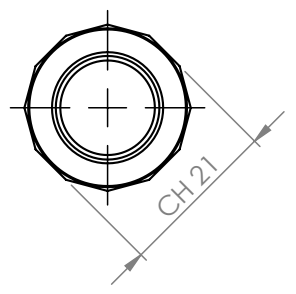

B

QUOTA VARIABILE PER TIPOLOGIA DI CAVO (63~)

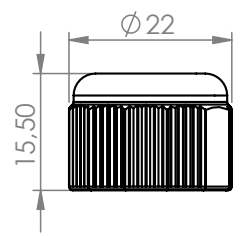
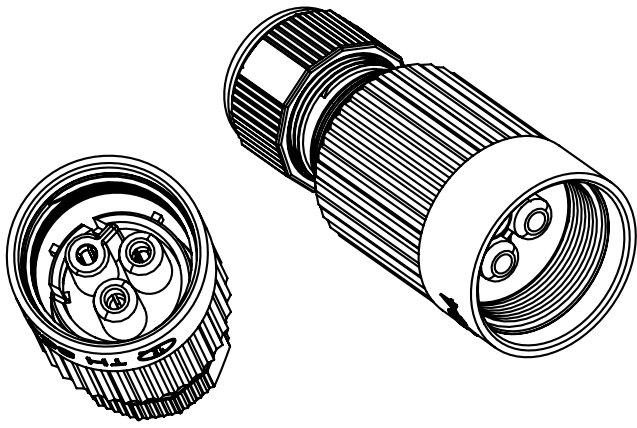
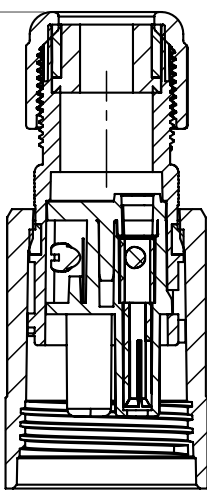

SEZIONE A-A

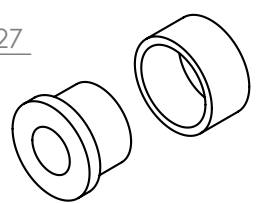
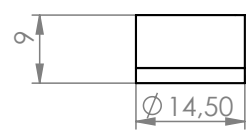
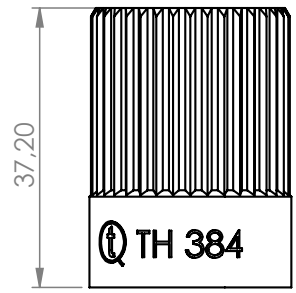

C

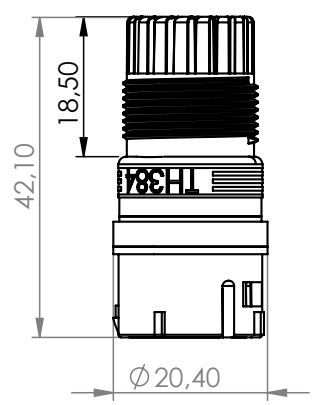

D

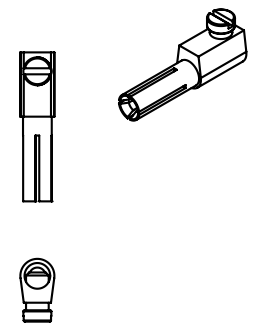
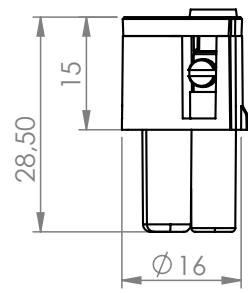
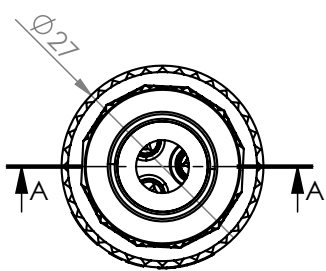

E



Via Bancora e Rimoldi,27  
22070 Guanzate (CO)

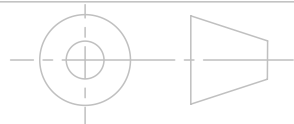

SCALA  
SCALE  
1:1

FORMATO  
FORMAT

N°REVIS.  
REVIS.N°

VALIDO DA:  
VALID FROM:

Questo disegno è di proprietà della Techno srl, senza autorizzazione scritta della stessa non potrà essere utilizzato per la costruzione del pezzo rappresentato ne venir comunicato a terzi o riprodotto. La società proprietaria tutela i propri diritti a rigore di legge.

This drawing is the exclusive propriety of TECHNO Srl. This document without written consent cannot be reproduced or shown to third parties or used elsewhere. All rights are reserved also in the case of a patent or registered design being granted.

DISEGN. DRAWN	DATA-DATE	NOME-NAME
APPROV. APPROVED	06-09-2013	GABRIELE FLORES

CODICE CODE	DESCRIZIONE-DESCRIPTION	N°DISEGNO DRAW N°
MATERIALE MATERIAL	PATH-PERCORSO	FILE
	THB.384.B1A	THB.384.B1A

VARIAZIONI ALTERATIONS	DATA DATE	COORDINATE COORDINATES	MOTIVO DELLA REVISIONE-CAUSE OF MODIFICATION	RIFER. IND.